

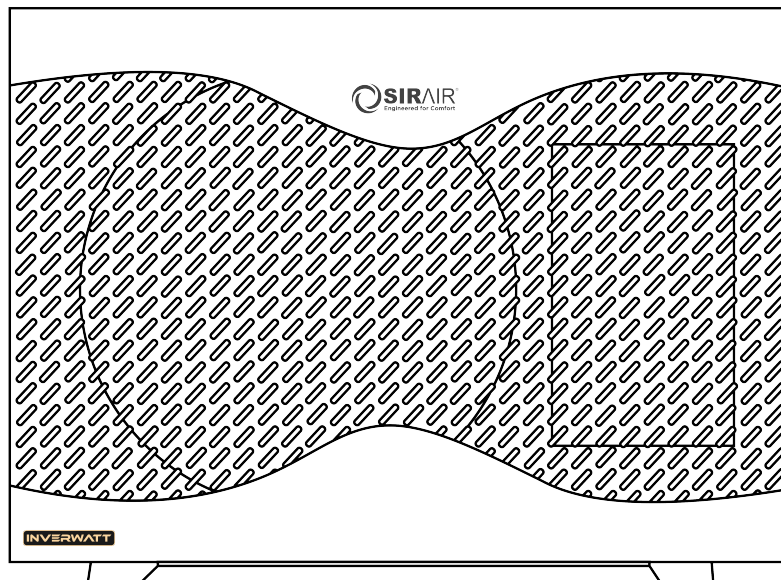

Installation & Operation Manual

INVERWATT







Full Inverter Swimming Pool Heat Pump



Thank you very much for purchasing our product, please keep and read this manual carefully before you install heat pump.





Packing List

No.	Name	Qty.	Remark
1	Installation & Operation Manual	1	
2	Wire-controller	1	
3	Wire controller box and sponge pad (to be installed on the heat pump shell)	1	
4	Drain-pipe (2 m)	1	
5	Drain-pipe connector	1	
6	Rubber shock absorber	4	
7	Heat Pump Unit (The pipe connector has been installed on the machine)	1	

Please keep installation manual properly, and read it carefully before using.

 The unit must be installed by professional personnel according to the instructions in this manual.

 **WARNING:** if the unit is installed in locations that are at risk of lightning strikes, lightning protection measures must be provided.

 **WARNING:** All water must be drained from the unit during winterization or it could freeze inside the unit causing damage to the internal components.

Content

Accessories.....	5
Safety.....	6
Heat pump working principle.....	7
Installation of the unit.....	9
Installation of the pipeline.....	12
Installation of optional accessories.....	14
Installation and operation of electric devices.....	15
Instruction for operation	19
Wireless/Remote control.....	26
Initial operation and settings	35
Operation and maintenance.....	36
Fault analysis and solution method.....	38
Technical parameters.....	39
After-sale service.....	40

1. Accessories

Each unit produced by our factory comes with the following accessories:

No.	Name	Qty.	Use
1	Installation & Operation Manual	1 PC	User Guide to install the unit
2	Wire controller	1 PC	Used for the machine operation interface
3	Drain-pipe	1 PC	Used for draining the condensate water
4	Drain-pipe connector	1 PC	To connect the drain pipe to the heat pump
5	Rubber shock absorber	4 PCS	To reduce vibration and noise
6	Heat pump unit	1 SET	For heating water

In order for the system to work the following parts are required

No.	Name	Qty.	use
1	Water pump	1	To circulate the pool water
2	Filter system	1	To clean the pool water which passes through the heat pumps
3	Water pipes system	1	To connect the equipment and circulate the water in the pool

NOTE

The types and quantity of the water pipes, valves, filter equipment, sterilizing equipment used for the swimming pool heating/circulation pipe system, depend on the project design. We do not recommend to install auxiliary electric heaters in the system.

2. Safety

Range of application:

1. Power supply: 220V-240V/1N~50Hz.
2. Ambient temperature: $-15^{\circ}\text{C}\sim 43^{\circ}\text{C}$:
3. Working water temperature: Min. inlet water temperature 8°C , Max. Outlet Water Temperature 40°C . If the system is always used beyond the available water range,

- The installation should be done by the professional persons, to prevent leaking, electric shock or fire.
- Confirm the ground connection, if the ground connection is not correctly done, it may cause electric shock.

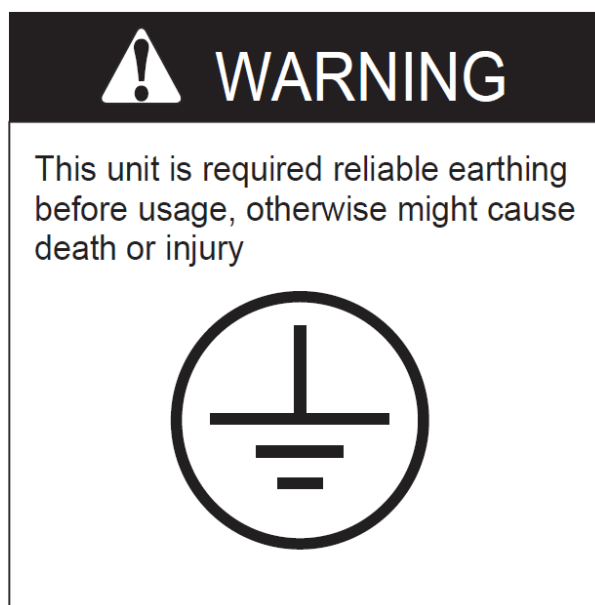

THE UNIT MUST BE EARTHED PROPERLY BEFORE USAGE

When installing the heat pump in a small room, make sure it is well ventilated.

- Don't put fingers or objects into the air inlet outlet as the rotating fan could cause serious injuries.
- If you smell anything burning, turn off the manual power switch immediately, stop operation and contact the after-sale service department. Continued abnormal operation may cause electric shock fire.

-
- When the unit needs to be removed or re-installed, please ensure that the work is carried out by qualified professionals. If the installation is not correct, it may cause unit operation failure, electric shock, fire, hurt, leaking, etc.
 - Please ensure that any repairs are carried out by qualified professionals: failure to make proper repairs could cause unit operation failure, electric shock, fire, hurt, leaking, etc..
 - Do not install the unit near flammable sources, as any leakages could cause a fire.
 - Make sure the base on which the unit is installed is strong enough to support it.
 - Make sure a leakage protection switch is installed to prevent electric shock or fire.
 - When cleaning the unit, stop operation, switch off the power and disconnect the power..

3. Heat pump unit working principle

3.1 Heat pump operation

Heat pumps use heat from the sun by collecting and absorbing energy from the outside air. This energy is then compressed and transferred to the pool water. Your existing water pump circulates the water through the heat pump, which is normally installed next to the pool filtration system, and the water warms up. The heat pump timer can be set so that the pump operates at the times you want: for example, during daylight hours from 9am to 5pm.

- The unit contains a fan that draws in outside air and directs it over the surface of the EVAPORATOR (energy collector). The liquid refrigerant inside the EVAPORATOR coil absorbs the heat from the outside air and becomes a gas.
- The warm gas inside the coil passes through the COMPRESSOR, which concentrates and increases the heat to form a very hot gas, which then passes through the CONDENSER (water heat exchanger). It is here that the heat exchange occurs as the heat from the hot gas is transferred to the cool swimming pool water circulating through the heat exchanger.
- The pool water becomes warmer and the hot gas returns to its liquid form as it flows through the CONDENSER coil. The gas then passes through the Electronic Expansion Valve and the whole process begins again.
- Developments in heat pump technology mean that today heat pumps can efficiently collect heat from the outside air even when the temperature is as low as 7-10°C. This means that for tropical and subtropical climates the pool can be maintained between 26°C and 32°C.

3.2 Air source heat pump working principle

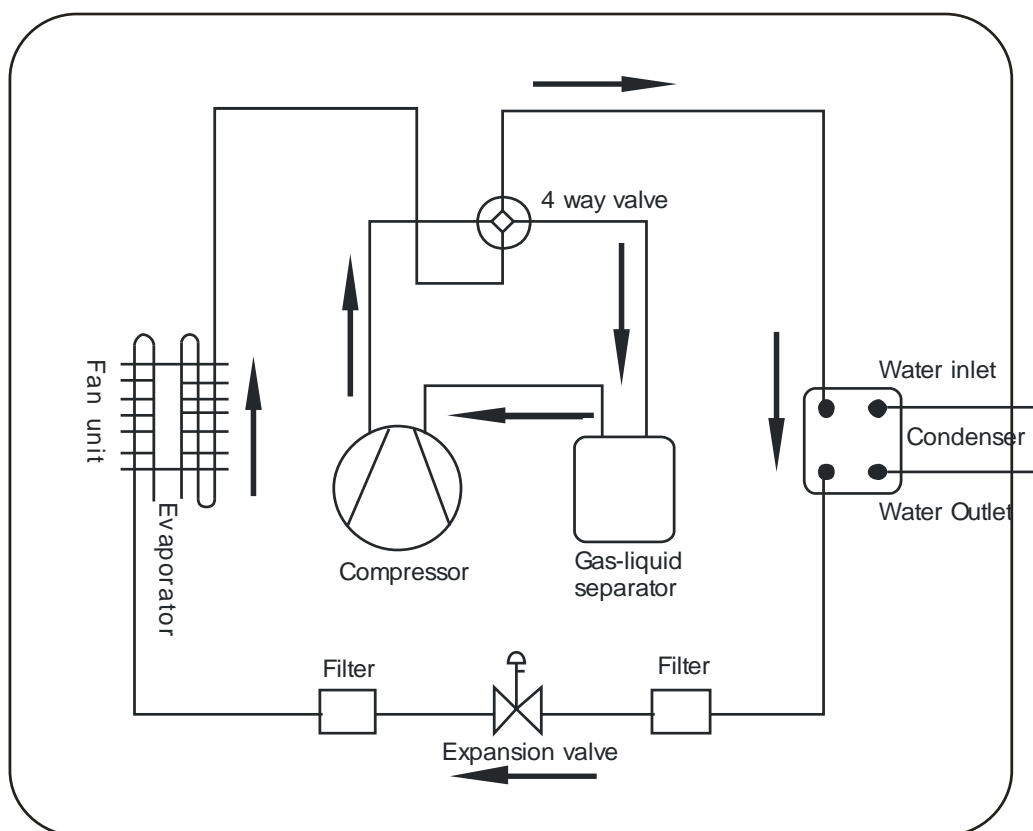

Figure 1

Q_c (Heat energy) = Q_a (Compressor consumption) + Q_b (Heat energy absorbed from ambient environment)

4. Installation of the unit

4.1 Installation Guidelines

- Avoid installations in locations containing mineral oil.
- Avoid installation in locations where the air contains salt or other corrosive gases.
- Avoid installation in locations with serious power supply voltage fluctuation.
- Avoid installation in unstable places, such as a car or cabin.
- Avoid installation near flammable items.
- Avoid installation in locations with strong electromagnetic forces.
- Avoid installation in locations with harsh environmental conditions.

4.2 Installation check

- Check the model, number, name etc, to avoid incorrect installation.
- Make sure there is enough space for installation and maintenance.
- Install in a dry well-ventilated place and make sure there are no obstructions around the air inlet and outlet.
- Make sure the supporting base is strong enough and prepared to that shocks can be avoided.
- The power supply and diameter of the cables used must be in accordance with the electrical installation requirements.
- Electrical installation must comply with the relevant technical standards of electrical equipment, and electrical insulation work must be done.
- The unit must be put horizontally for at least eight hours before running.

4.3 Installation space

Please observe the space requirements indicated below for optimal operation and maintenance.

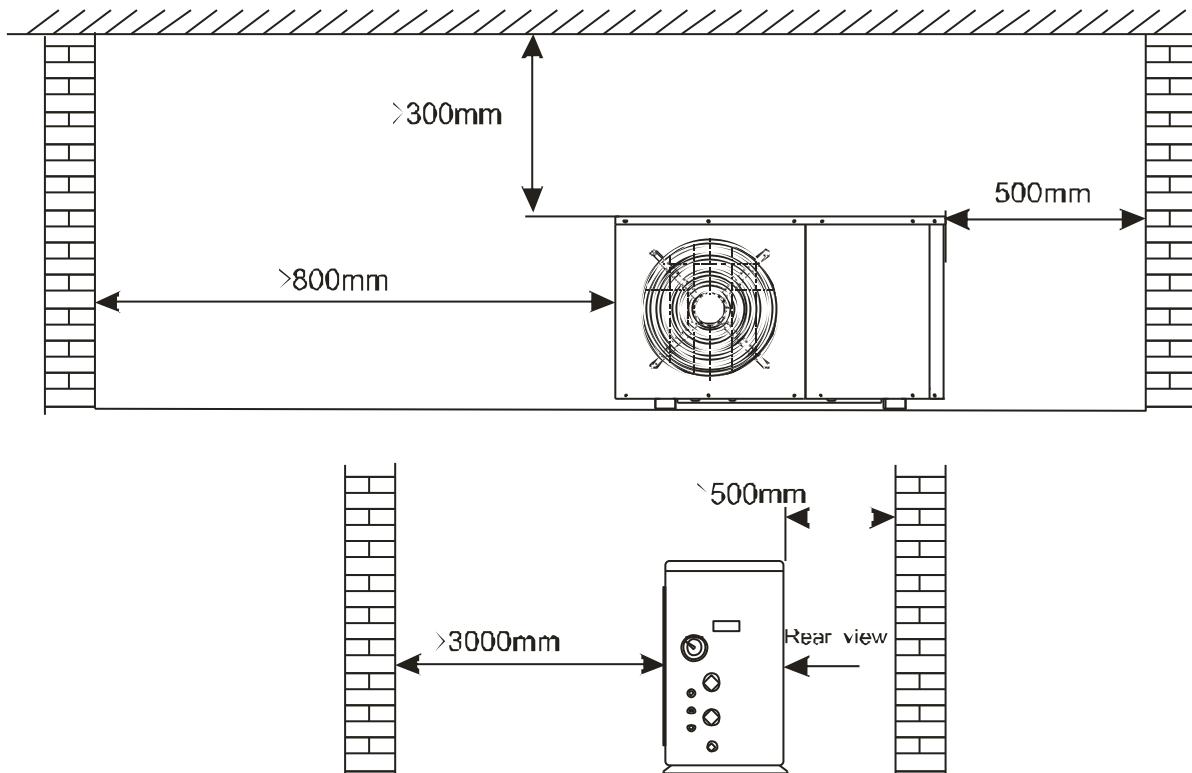

Figure 2. Horizontal installation space requirements (mm)

4.4 Heat pump dimensions

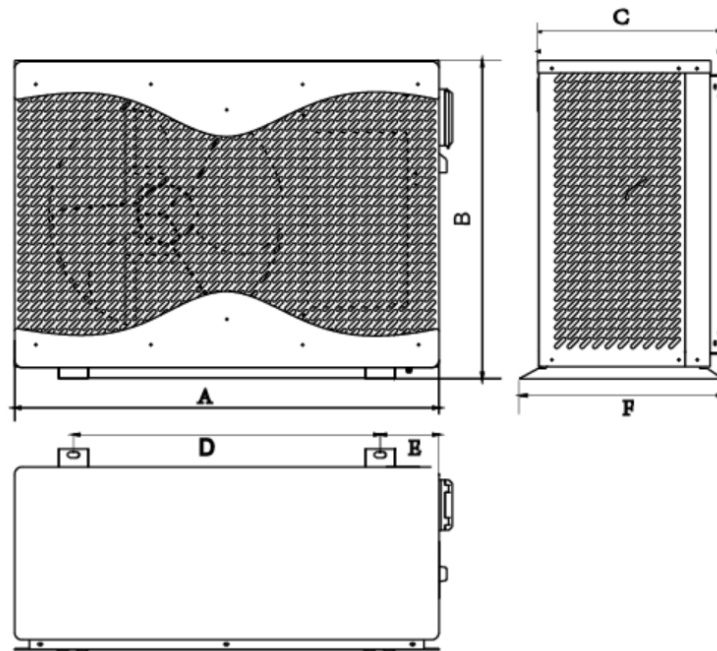

Figure 3 Heat pump dimensions

Size(mm) Model No.	A	B	C	D	E	F
BYC-007TG1 BYC-010TG1	821	587	405	474	173	403
BYC-013TG1 BYC-017TG1 BYC-021TG1	850	637	405	614	118	403
BYC-030TG1 BYC-030TG3	1036	793	450	614	211	448

4.5 Installation base for heat pump

Please refer to Figure 5.

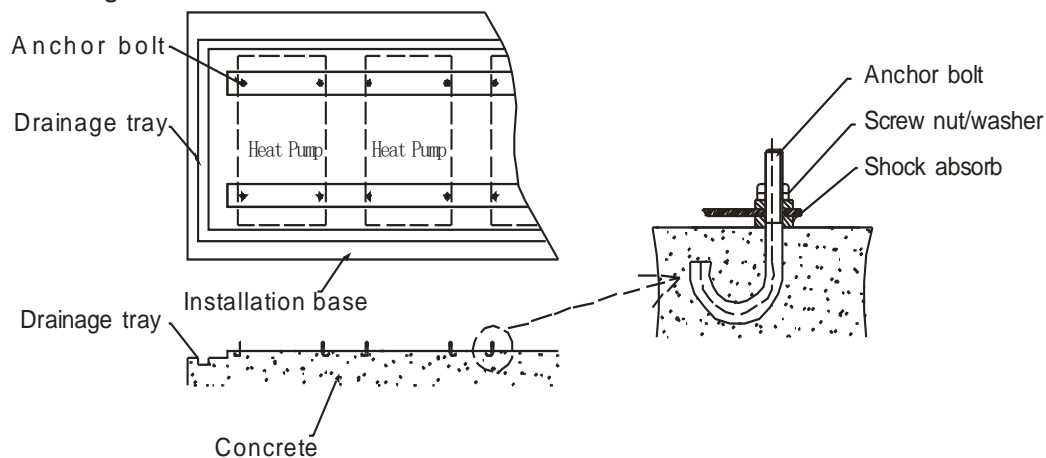

Figure 4 Installation base

4.6 Lifting

- Please use four or more soft lifting belts to move the sets (see Figure 6).
- Please use protective plates on the surface of the units when handling to avoid scratches and deformation.
- Double-check that the support base is strong enough before fixing the unit.
- The heat pump will produce condensation water: remember to provide a drainage channel when making the installation base.
- Please install shock absorbers on the surface of the base.

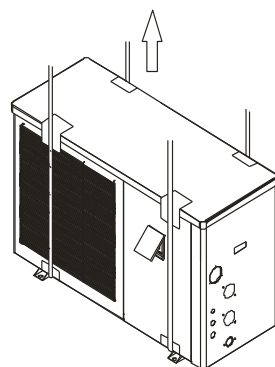

Figure 5 Lifting diagram

5. Installation of pipelines

5.1 Attention

- Prevent air, dust and other material from going into the water pipes.
- Fix the whole system before installing the water pipes.
- Water inlet and outlet pipes should be protected by an insulation layer.
- Make sure that there is a stable water flow, to prevent excessive throttling.
- Do not handle, move or lift the unit by holding the water inlet and outlet pipe: use only the holes on the beam of the base (see Figure 9)
- When connecting the water inlet and outlet pipes, use two pipe wrenches to adjust the two parts of the pipes, and make sure the water inlet and outlet pipes do not twist (see Figure 7).

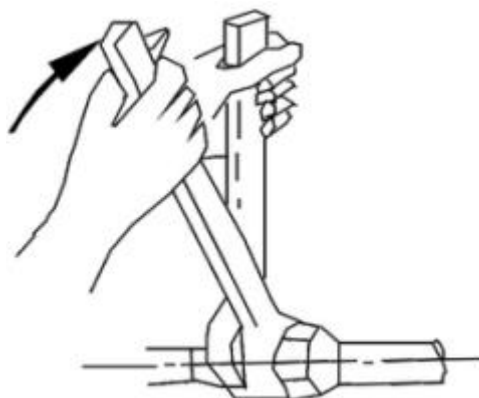

Figure 6

5.2 Instructions

5.2.1 Symbols

Valve	Filter	Flexible connection	Check valve	Pump	Air valve	Pressure gage	Flow switch	Feeding tank	Flared joint	Hair collector	Sand Filter	Chemical dosing system

Figure 7

5.2.2 Pipeline installation diagram

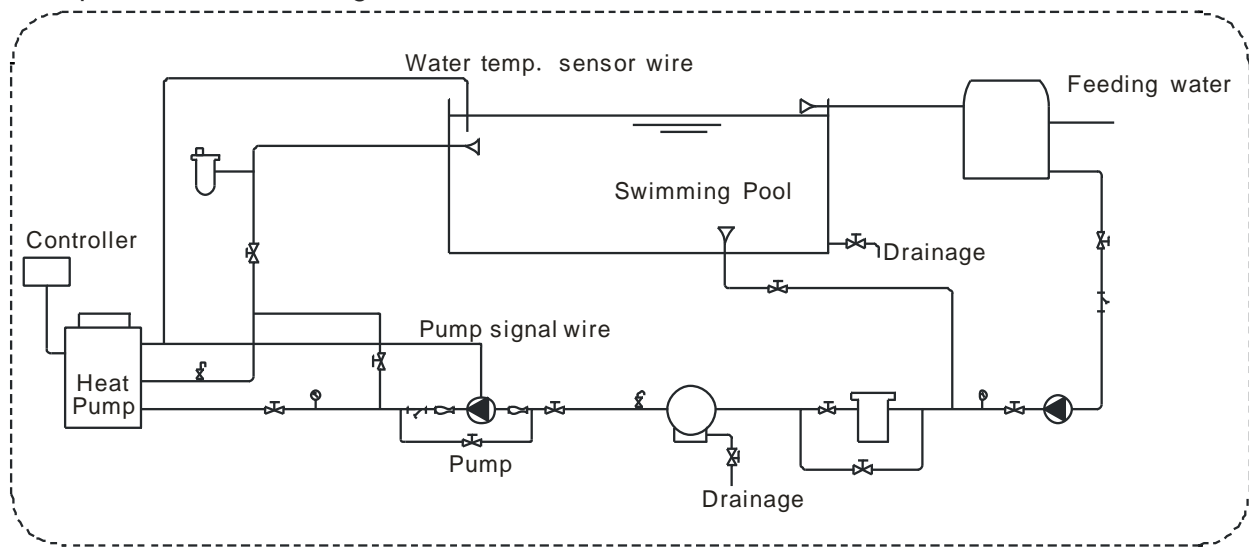

Figure 8 Diagram (Single unit for reference)

- It is recommended to install a one-way valve for each unit to prevent water back flow.
- Multiple units can be installed as part of a system, but each unit should be controlled independently.
- All pipes and valves should be insulated.

5.2.3 Connection sizes

Model No.	Inlet	Outlet
BYC-007TG1	DN50	DN50
BYC-010TG1		
BYC-013TG1		
BYC-017TG1		
BYC-021TG1		
BYC-030TG1		
BYC-030TG3		

- The pipe pressure and flow rate should be calculated before selecting the diameter of the pipe, pressure drop range is 0.3~0.5 kgf/cm² (3~5m) head pipe flow rate range is 1.2~2.5 m/s.
- The hydraulic calculation should be made after selecting the pipe diameter. If the resistance is more than the pump head, then a more powerful pump or larger pipes are required.

5.2.4 Required Water Quality

- Bad quality water will produce more lime scale and sand: this kind of water should be filtered and

demineralized.

- The water quality should be analyzed before operating the unit: PH value, conductivity, Chloride ion concentration and sulphate ion concentration should be checked.
- Acceptable water quality shown below:

PH value	Total hardness	Conductivity	Sulphate ion	Chlorine ion	Ammonia ion
7 ~ 8.5	< 50ppm	<200 μ V/cm(25°C)	None	< 50ppm	None
Sulfate ion	Silicon	Iron content	Sodium	Ca	
< 50ppm	< 50ppm	< 0.3ppm	No requirement	< 50ppm	

- Suggested filter mesh = 40.

6. Installation of optional accessories

6.1 Selection of the water pump

- The circulation pump is required for the system to operate, there is a terminal connection for the pump (single phase)

NOTE 

For single-phase water pumps, please check the wiring diagram.

- Head of circulation pump = height difference between water level and main unit + total pipeline resistance (determined by the hydraulic calculation) + pressure loss of main unit (see nameplate on heat pump).

NOTE 

Multiple units are installed in parallel place more demand on the water pump requirement.

6.2 Water pipe selection

- The selection of the water pipe should be based on the actual system specifications
- The flow switch can be installed horizontally or vertically. If installed the direction of the water flow must be upwards and NOT downwards.
- The flow switch must be installed on a straight pipeline, and there must be more than five times the length of the pipe diameter on either side of the flow switch (see Figure 9 below). The direction of fluid must follow the arrow on the controller. The terminal block should be installed in a position that is easy to operate.

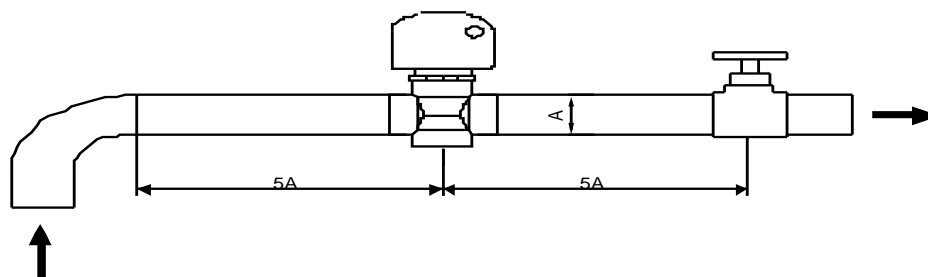

Figure 9

7. Installation and Operation of electrical devices

7.1 Electrical wiring

- The unit should have a dedicated power supply in accordance with the recommended voltage.
- Unit power supply circuit must have an effective external grounding.
- Wiring and electrical connections must be made by qualified professionals in accordance with the wiring diagram.
- Power line and signal line layout should be neat and cables should not interfere with each other.
- Do not install the units if the power supply specifications are not met.
- After all wiring connections have been completed, check them again carefully before switching on the power.

7.2 Electrical Wiring Specification

Model	Electrical Wiring Specification
BYC-007TG1 BYC-010TG1 BYC-013TG1 BYC-017TG1 BYC-021TG1 BYC-030TG1 BYC-030TG3	3*2.5 mm ²
Terminal	Terminal cable max. 4 mm ²

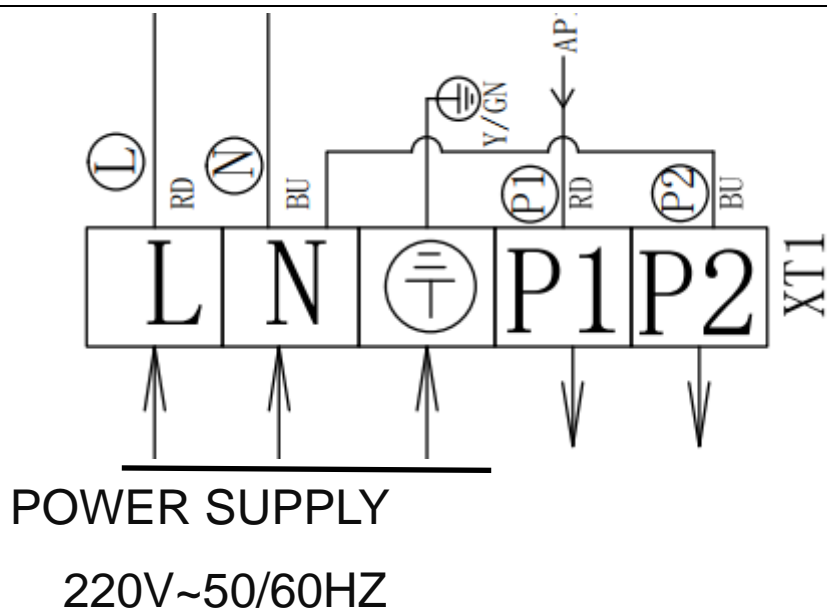

Figure 10 220V~50/60HZ single-phase

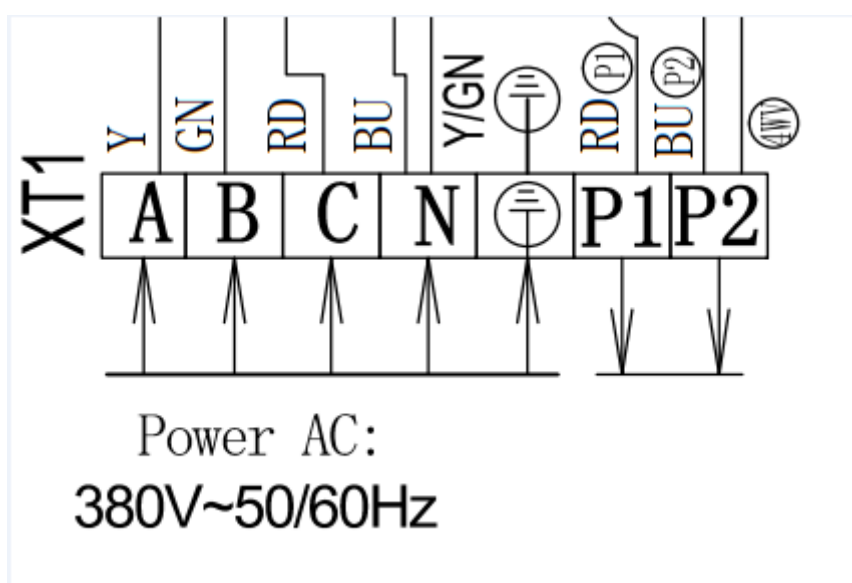
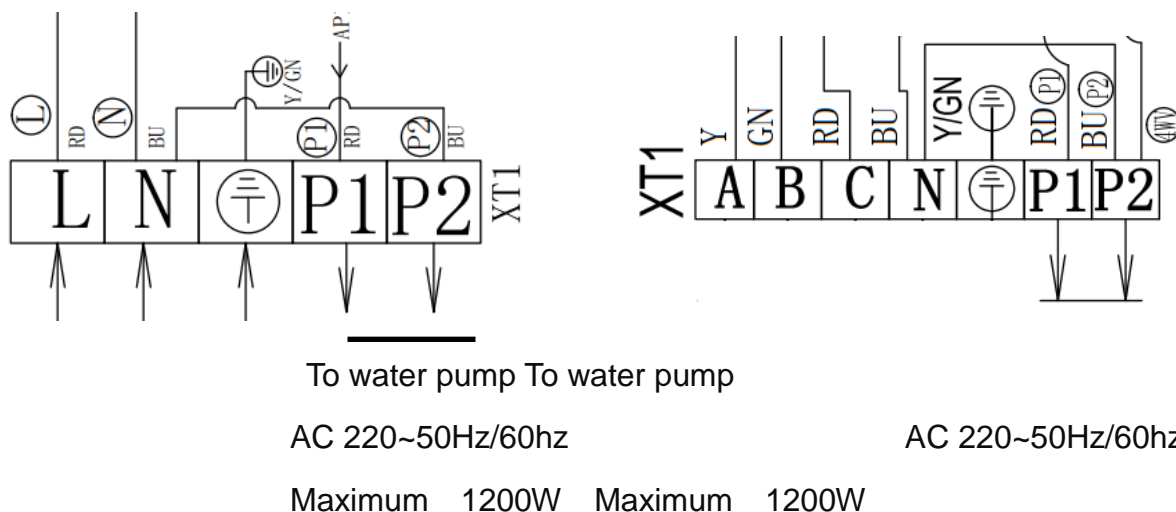

Figure 11 380V~50/60HZ three-phase

7.3 Circulation water pump installation

The heat pump only provides a signal for the circulation water pump, A separate A.C. Contactor is required to connect the circulation pump.



NOTE:
Only for signal control, not direct connection to power supply

Figure 12

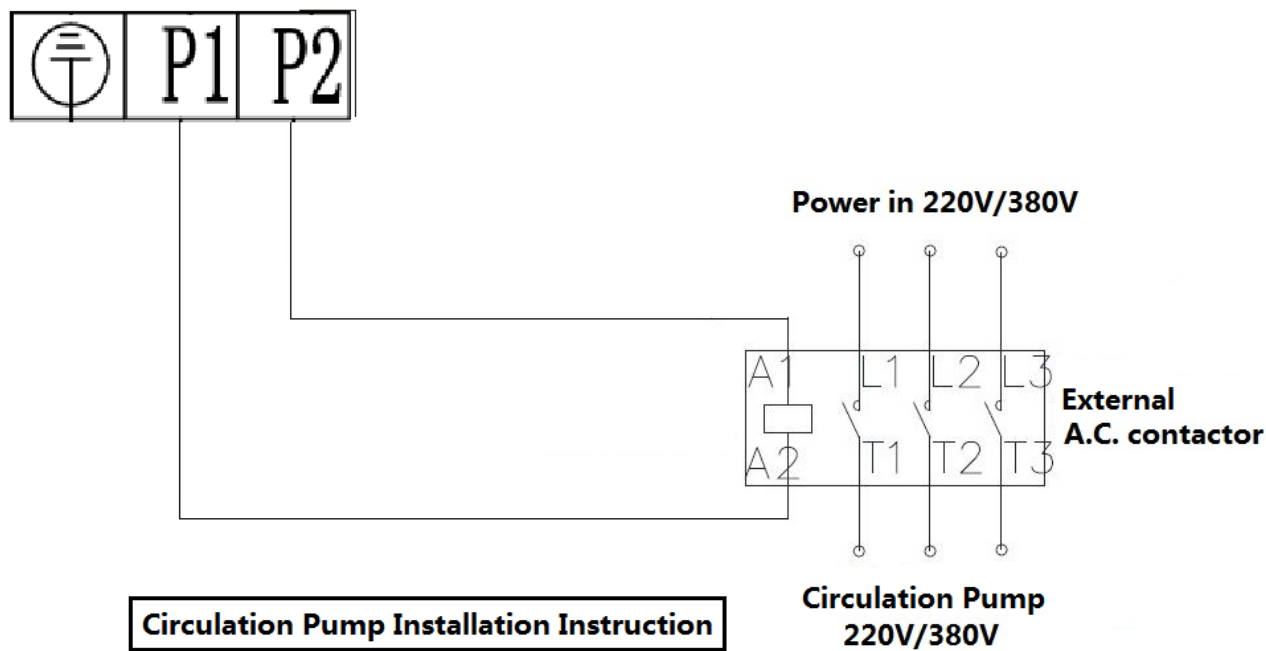

Figure 13

7.4 Electric wiring diagram

COMP : COMPRESSOR	GND : GROUND
AMBT: AMBIENT TEMPERATURE SENSOR	WFS: WATER FLOW SWITCH
LOW : LOW PRESSURE SWITCH	HIGH : HIGH PRESSURE SWITCH
COIL: EVAPORATOR COIL TEMPERATURE SENSOR	OWT/INWT: INLET / OUTLET WATER TEMPERATURE SENSOR

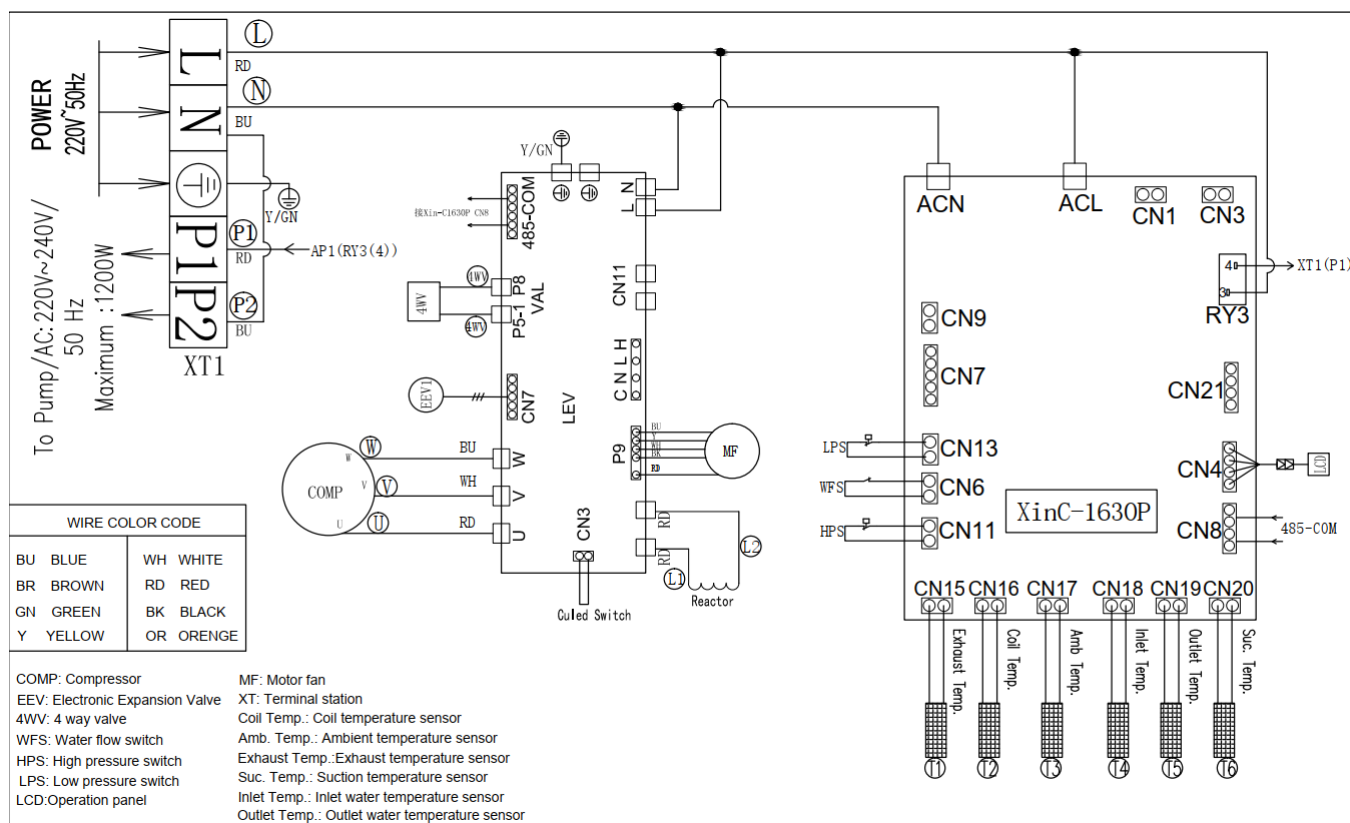

Figure 14 Electrical wiring diagram

(For model BYC-007TG1、BYC-010TG1、BYC-013TG1、BYC-017TG1、BYC-021TG1)

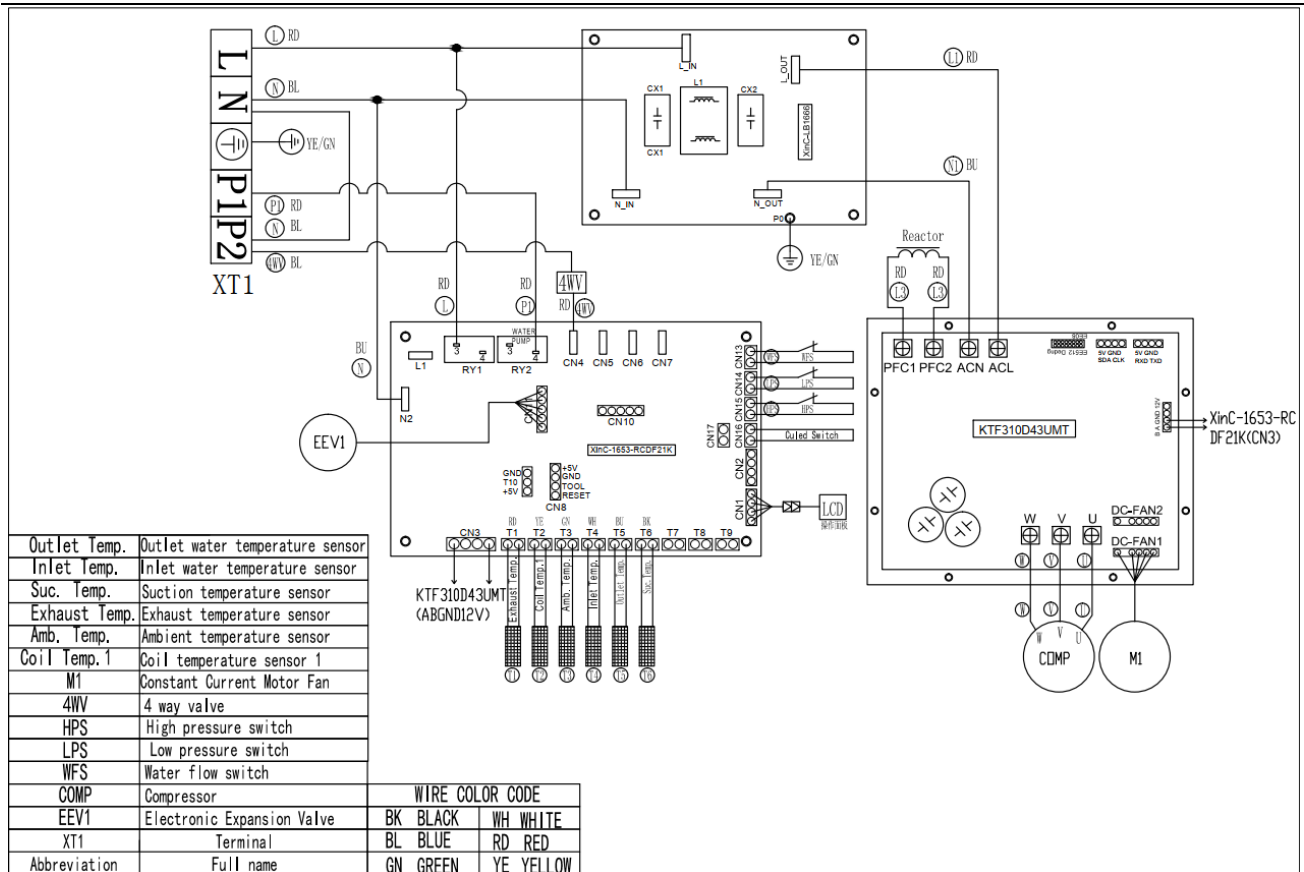

Figure 15 Electrical wiring diagram (For model BYC-030TG1)

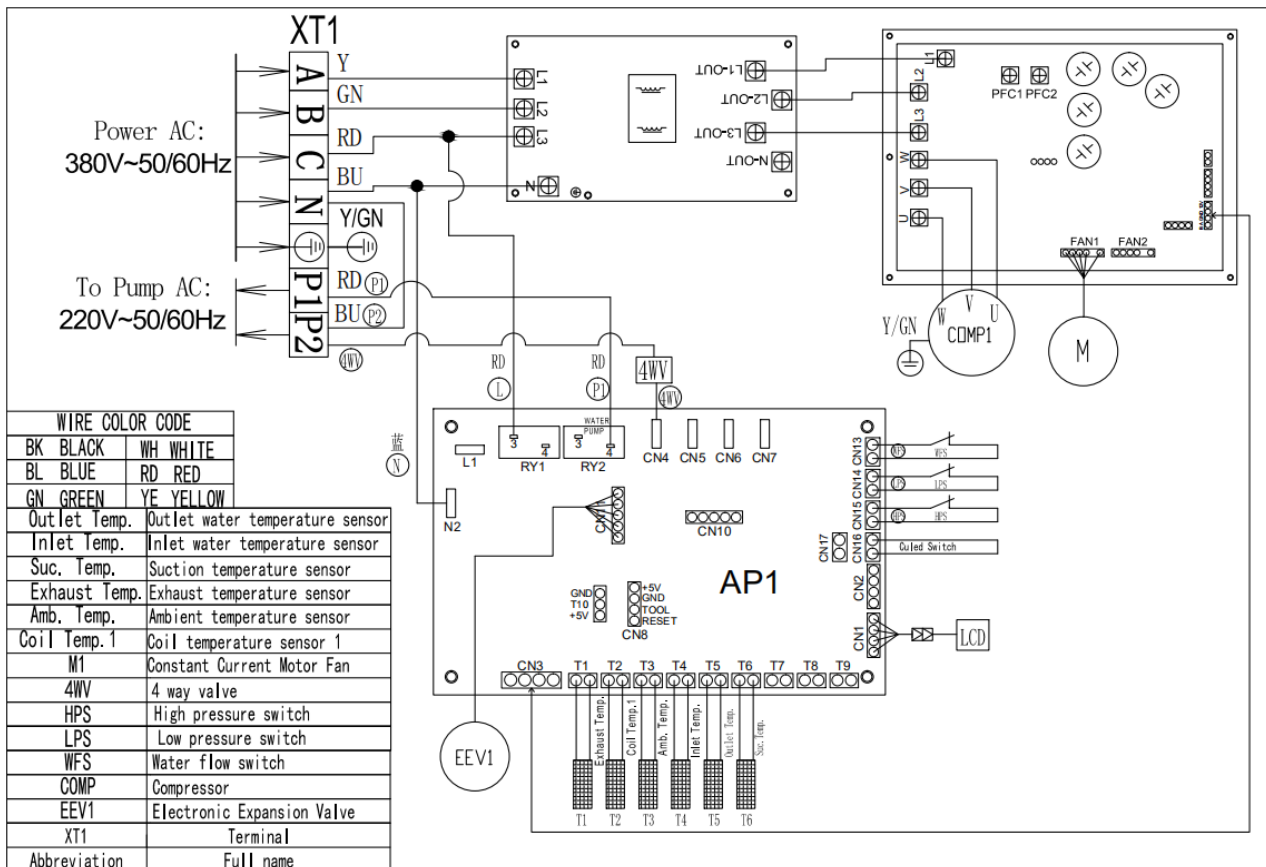





Figure 16 Electrical wiring diagram (For model BYC-030TG3)

8. Instructions of Operating





1. Controller Operation



- Press  button to change between Heating, Cooling and Auto modes
- In heating mode:  lights up
- Auto Mode: When heating in Auto mode,  +  light up

When cooling in Auto mode,  +  light up



- In cooling mode:  light up



Icon meaning:



 +  ----- Cooling mode, when set to cooling, this icon is always on;

 +  ----- Heating mode, when set to heating, this icon is always on;

 ----- Auto mode, when set to Auto, this icon is always on;

 +  -----Fast heating, when set to fast heating, these two icons are always on;

 +  ----- Fast cooling, when set to fast cooling, these two icons are always on;

 +  ----- Slow heating mode; when set to slow heating mode, these two icons are



always on;





----- Slow cooling mode; when set to slow cooling mode, these two icons are always on;







- **Temperature Setting**

✓ In the main interface, press  or  to adjust temperature setting. At the same time, the SET icon will light up. It will automatically exit after 3s without operation.

- **Inquiry and Setting of User Parameters**

*In the main interface, press and hold  for 3 seconds to enter the user parameter query interface. Press  or  to query each parameter.



*In the user parameter query interface, select a parameter and press  to enter the parameter setting, this parameter will flash, then press  or  to modify the value. Press  again to confirm this setting.

*In the Inquiry or Setting interface, it will return to main interface automatically if there is no operation for 30 seconds and the modified parameter value will be saved automatically. You



can also return to the main interface by the







- **Time Setting**

- ✓ Press and hold  for 5 seconds to enter real-time setting. The Hour & Minute will flash in the same time.



- ✓ Then press  again to enter Hour setting, the Hour icon will flash only, then press  or  to modify the value.

- ✓ Then press  again to enter Minute setting, the Minute icon will flash only, then press  or  to modify the value.

- ✓ Then press  again to confirm the setting. Or you can press  or no operation for 30 seconds to confirm the setting.



- **Timer Function**

- ✓ In the main interface, press  to enter the interface of the timer setting. You can set two timers. (Timer group 1 & Timer group 2).



- ✓
- ✓ Timer group 1 flashes, then setting this Timer On based on the process of real-time

setting. Then press  again to enter Timer Off setting of Timer group 1

- ✓ After that, press  to confirm the Timer setting. Then press  or  to enter into setting of Timer group 2, the setting process is the same to Timer group 1.
- ✓ The No. of Timer group will be showed on the main interface if the setting is valid.
- ✓ If the Timer on & Timer off is the same in one Timer group, then this Timer setting is invalid.

- ✓ You can press  or no operation for 30 seconds to confirm the setting.



● **Lock and Unlock**

- ✓ If there is no operation for 60 seconds, the controller will enter sleep status and the screen will be automatically locked. The screen “lock key” icon will be on.



- ✓ In the locked status, click any button to light up the screen. After pressing and holding the “ON/OFF” key for 5 seconds, the buzzer “Di” sounds, the key is unlocked, and the “lock key” icon turns off.

● **Restore to factory parameter settings (can be set only when heat pump is OFF)**

- ✓ In the main interface of the heat pump off, press and hold  and  at the same time for 5 seconds to restore the heat pump to factory default parameter settings. All the parameters will return to default value.



2. Parameters

2.1 Press and hold “+” for 3 seconds to enter temperature parameter checking status, then press “+” or “-” to select parameters.

Parameter	Name	remark
T1	Exhaust temperature	
T2	Gas return temperature	
T3	Water inlet temperature	
T4	Water outlet temperature	
T5	Evaporator coil temperature	
T6	Ambient temperature	
T7	Reserved	
T8	Reserved	
T9	Reserved	
T10	Reserved	
T11	Reserved	
Ft	Target frequency	
Fr	Current frequency	
1F	Electronic expansion valve opening	
2F	Reserved	
od	Mode	1:cooling 4:heating
Pr	Fan speed	AC fan: 1:high 2:middle 3:low DC fan: running speed (*10)
dF	Defrosting status	
OIL	Oil return status	
r1	Reserved	
r2	Bottom chassis heater	
r3	Reserved	
STF	4-way valve	
HF	Reserved	
PF	Reserved	
PTF	Reserved	
Pu	Water pump	
AH	High speed fan ON/OFF	

Ad	Middle speed fan ON/OFF	
AL	Low speed fan ON/OFF	
dcU	DC bus voltage	
dcC	Inverter compressor current (A)	
AcU	Input voltage	
AcC	Input current	
HE1	Fault code history	
HE2	Fault code history	
HE3	Fault code history	
HE4	Fault code history	
Pr	Protocol version	
Sr	Software version	

2.2 User parameter checking

Press “mode” button 3 seconds to enter parameter checking status, then press “+” or “-” to select parameter.

Parameter	description	range	default
L0	Heating	20°C ~ 60°C	26°C
L1	Adjustment of temperature difference before restart	2°C ~ 18°C	2°C
L2	Adjustment of temperature difference before stop	2°C ~ 18°C	2°C
L3	Cooling	2°C ~ 30°C	12°C
L4	Adjustment of temperature difference before restart when cooling	2°C ~ 18°C	2°C
L5	Adjustment of temperature difference before stop when cooling	2°C ~ 18°C	2°C
L6	Set temperature at Automode	8°C ~ 60°C	26°C
L7	Water pump mode	0: water pump always running 1: water pump will stop 60S after compressor stop, then run 5 min every(L8)min	0
L8	Water pump run 5min every(L8)min	3 ~ 180min	30

2.3. Error Code

Error Code	Description	Remark
E01	Exhaust temperature sensor failure	
E05	Evaporator coil temperature sensor failure	
E09	Gas return temperature sensor failure	
E17	Return water temperature sensor failure	
E18	Water outlet temperature sensor failure	
E21	Reserved	
E22	Ambient temperature sensor failure	
E25	water flow switch failure	
E27	Controller PCB and inverter driver communication failure	
E28	Controller PCB EEPROM failure	
E29	Inverter driver EEPROM failure	
P02	High/low pressure protection	
P11	Exhaust temperature too high protection	
P15	Temperature difference too big between water inlet and outlet	
P16	Super cooling protection at cooling mode	
P17	Anti-freeze protection	
P18	Reserved	
P19	Compressor overcurrent protection	
P24	Fan motor protection	
P25	Ambient temperature protection	
P26	Water outlet temperature too high protection	
P27	Evaporator coil temperature too high when cooling	
r02	Compressor driver failure	
r05	IPM module too hot protection	
r06	Heat pump current too big	
r10	DC voltage too big	
r11	DC voltage too small	
r12	AC voltage too small	
r24	Electrical power failure	

8. Wireless / remote control

Download and install the software:



User registration

When using the "smart life" software for the first time, user registration is required.

Click the "Create New User" link to enter the registration interface.

If you already have an account, just click login.

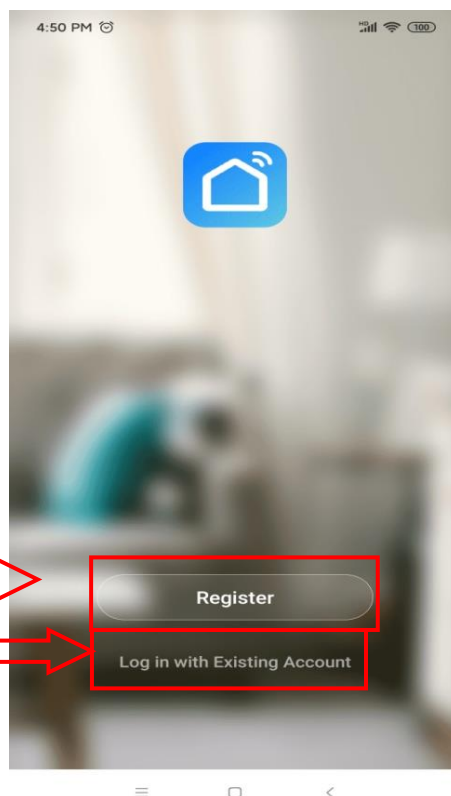

After entering the registration page, please follow the instructions on the page to register.

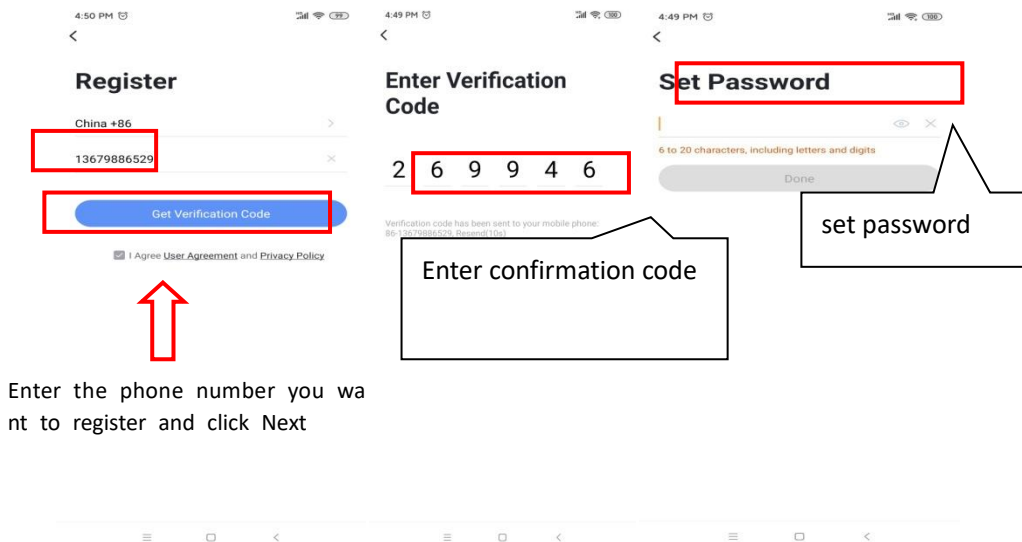

Enter the phone number you want to register and click Next

User login

After successful registration, the software will jump to the login interface or directly log in successfully, enter the correct "user name" and "password" to log in.

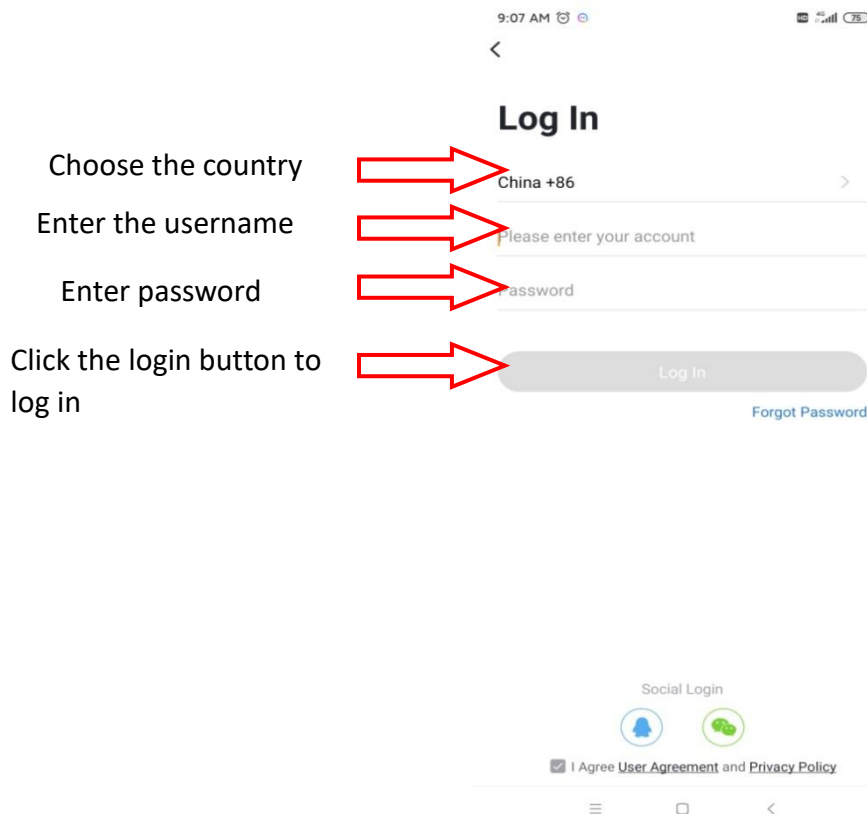

Choose the country



Enter the username



Enter password



Click the login button to log in



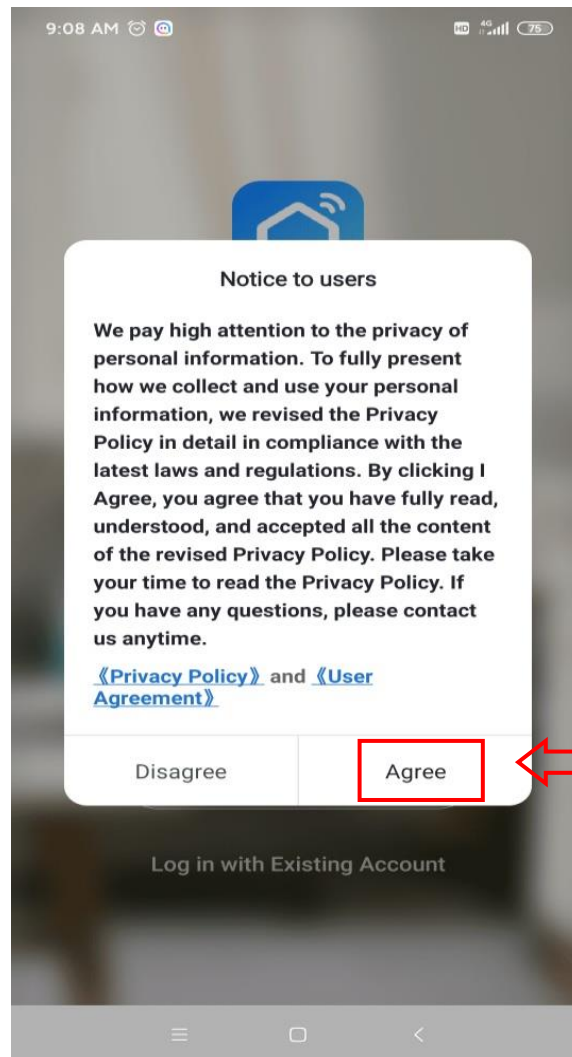

Need to select "Agree"

The phone needs to be connected to the network through the WIFI network

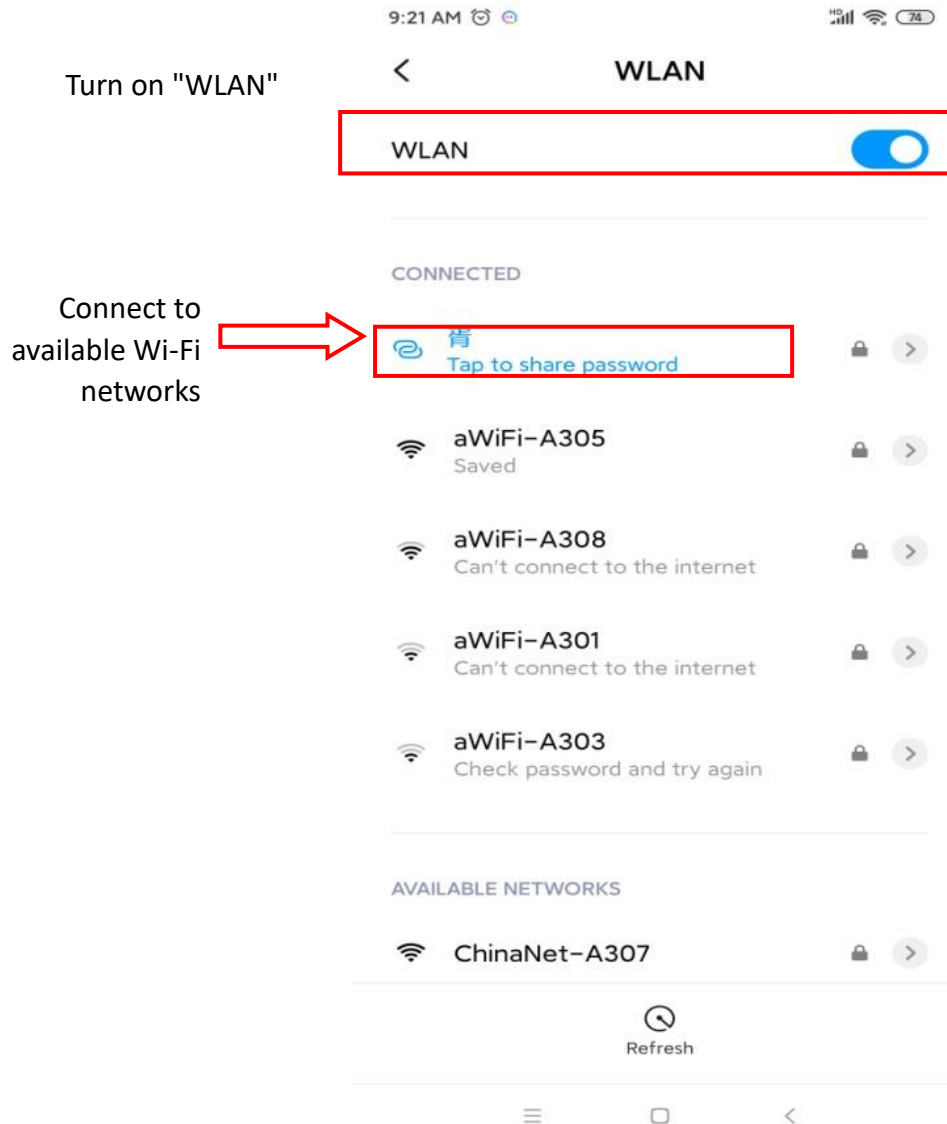

This WIFI is not the WIFI in the module but the WIFI that can be connected to the Internet;

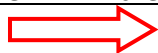

After users log in to the software, they can add devices

Device binding

Click "+" or "Add Device" in the upper right corner to bind.

Click to enter the "Add Device Type" interface

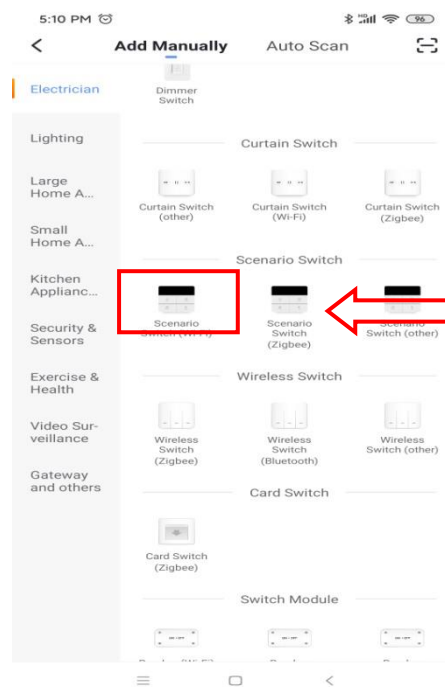
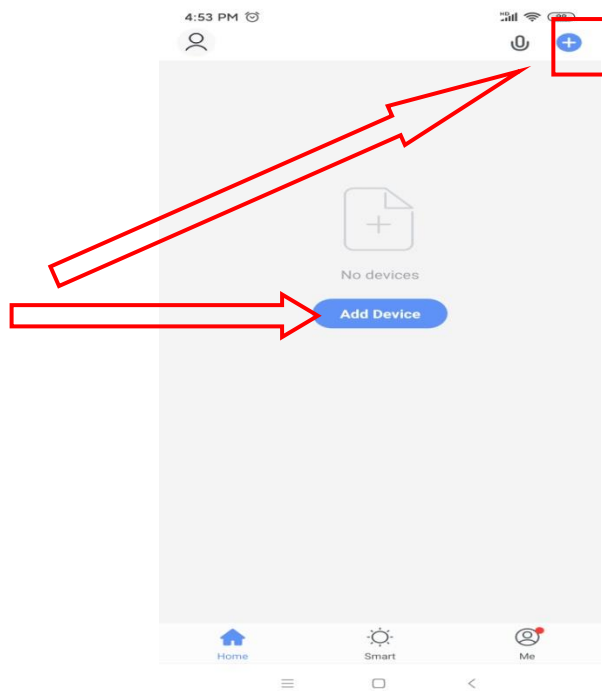

Choose "Icon Logo"

After completing the "Select Device Type", enter the "Add Device Interface", and the network configuration methods are divided into "default mode (WI-FI fast connection)" and "compatibility mode (hotspot distribution network)"

Default mode (WI-FI fast connection) :

The remote controller simultaneously press the up key + mode key for 3 seconds to enter the "default mode" distribution network

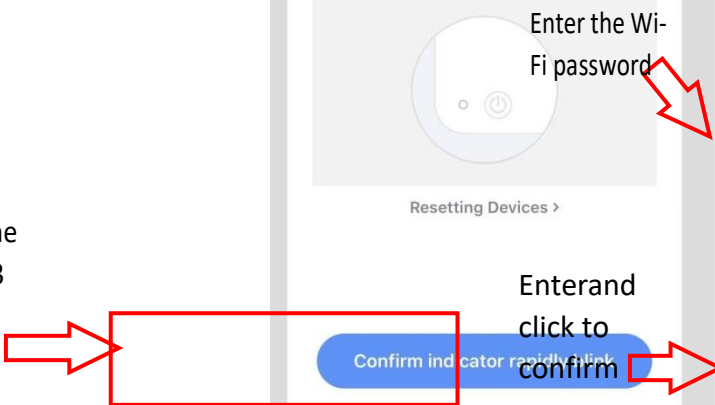
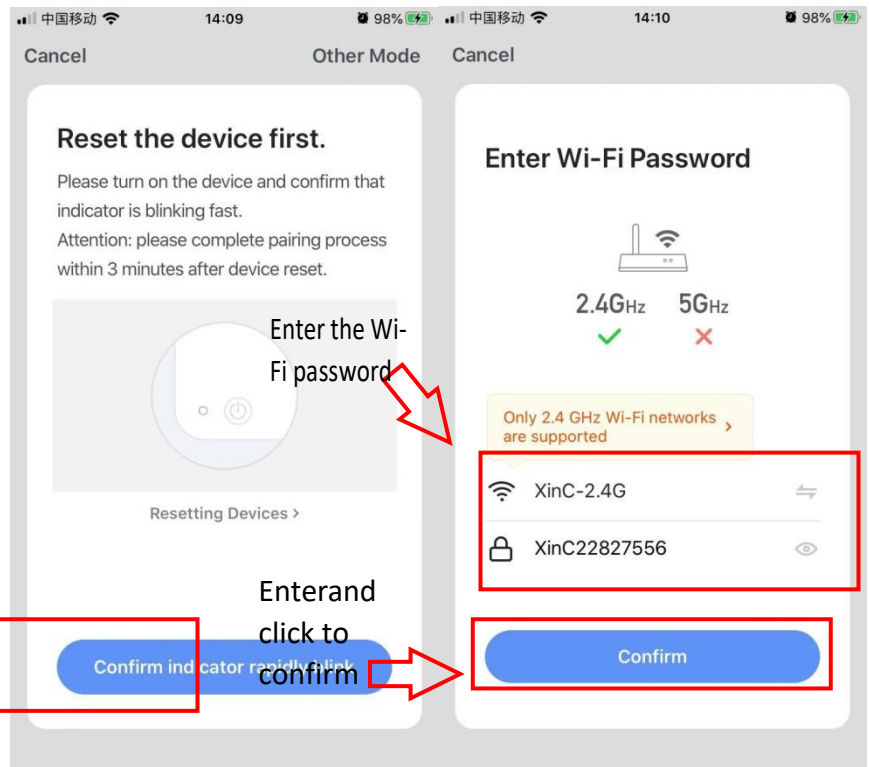

Enter the password and confirm it will jump to the connection interface

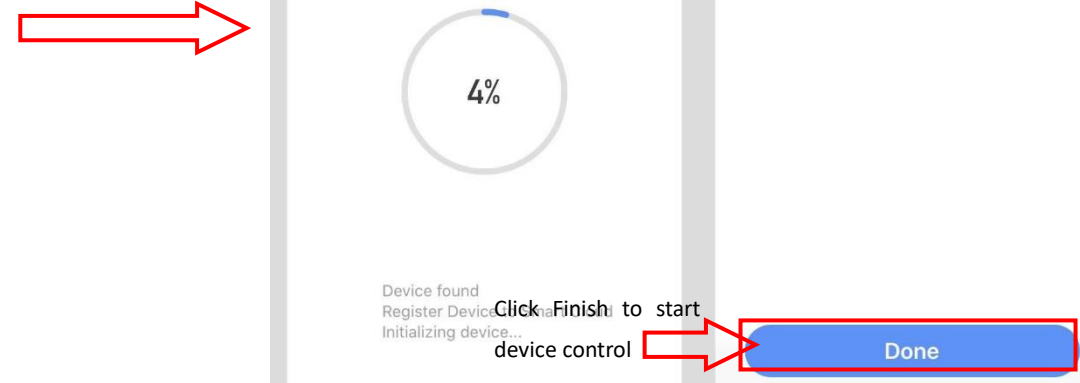
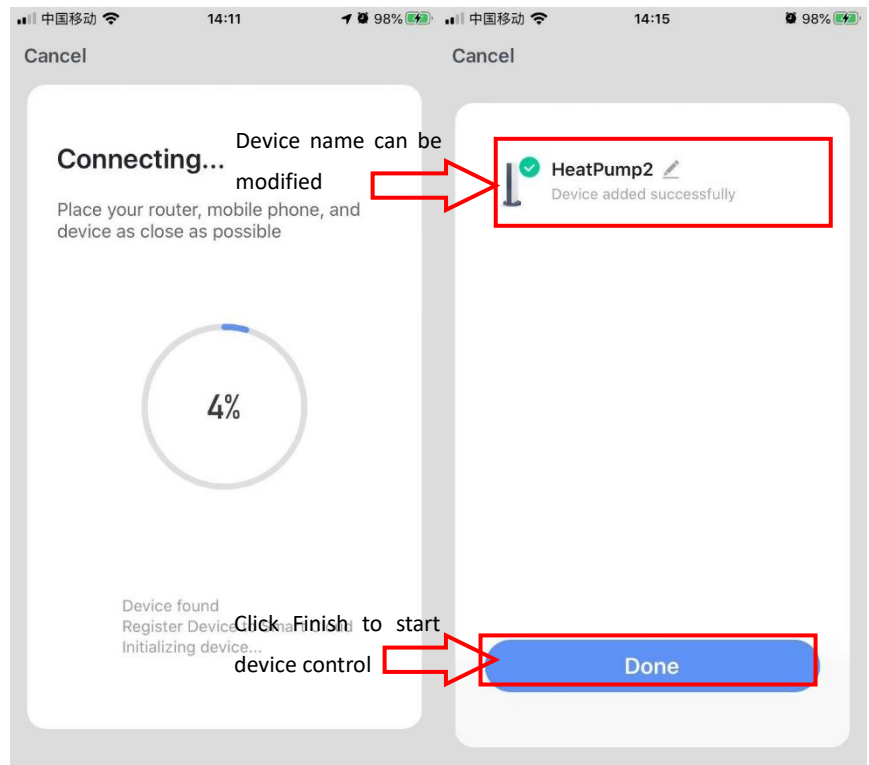

中国移动 14:17 98%

Close

Device not responding
Try "Switch Pairing Mode"

- ① Check if the device has been reset and the indicator is blinking quickly.
- ② Check if it is 2.4 GHz Wi-Fi.
- ③ Verify the Wi-Fi password.

Retry

Switch Pairing Mode

More device-pairing FAQs



If the network distribution fails, the APP will display the page as shown in the figure, you can choose to re-add or view the help.

Compatibility mode:

Select "Other Ways" in the Add Device

Press and hold the timing key +, down key +, power key simultaneously for 3 seconds to enter the "compatibility mode" distribution network.

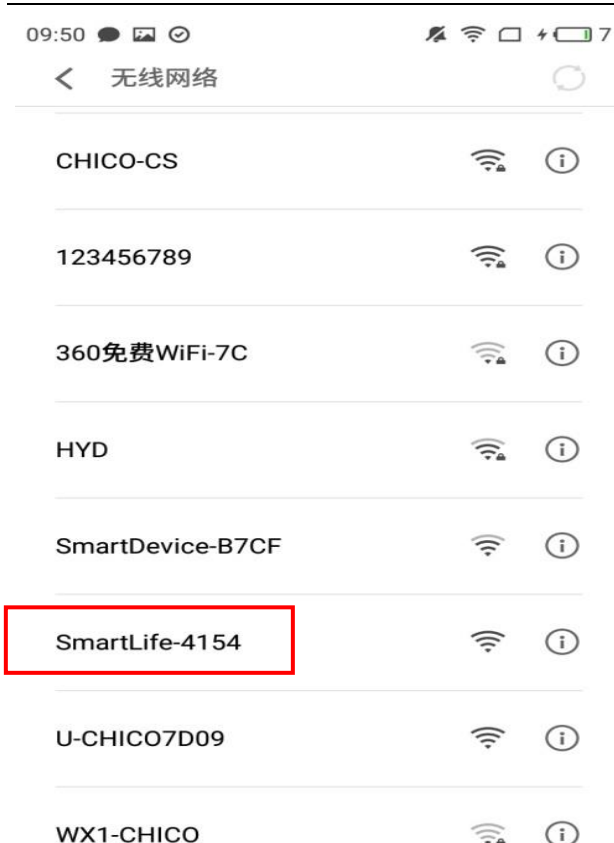

Click Go to connect and jump to the Wi-Fi interface, select Wi-Fi with the words SmartLife-xxxx

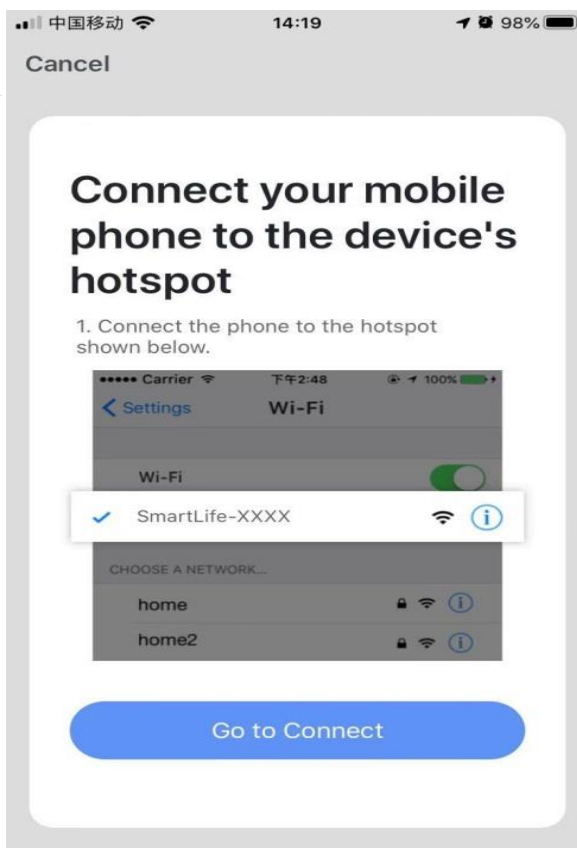

After selecting and connecting, return to the APP interface and enter the network distribution process

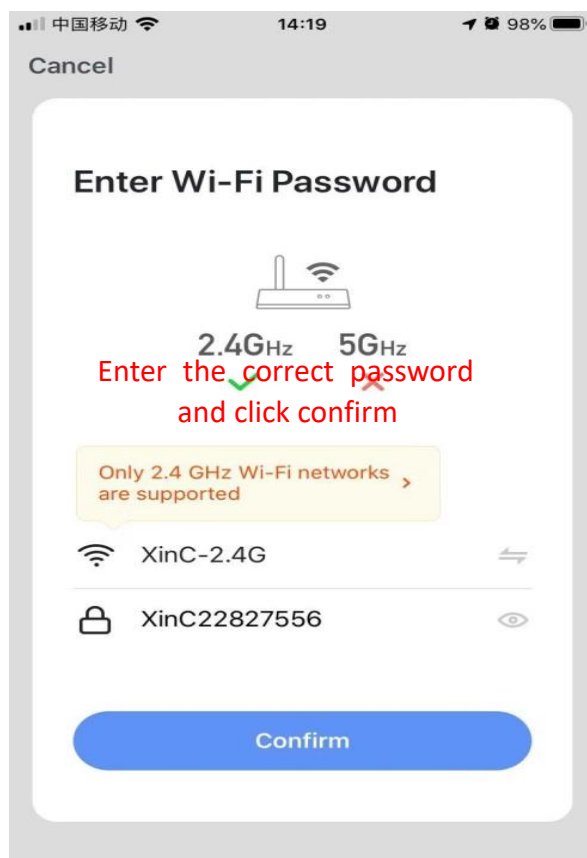

Enter the correct password and click confirm

Control introduction

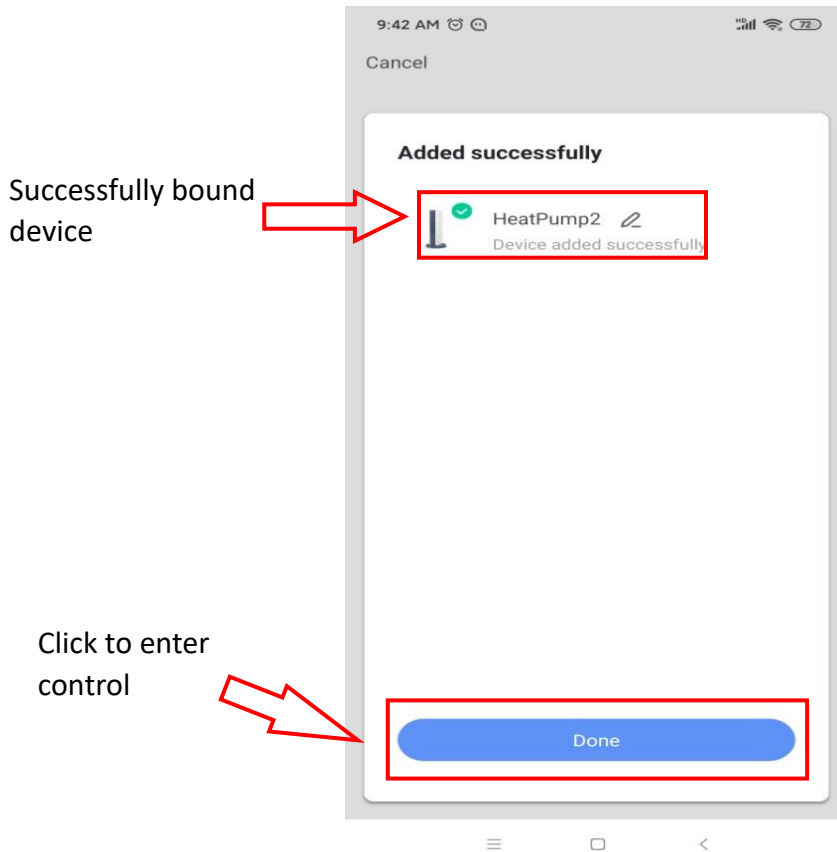

Successfully bound device

Click to enter control



Equipment details

Set temperature, and current inlet water

Set temperature adjustment

Switch machine control

Timing setting, can set the timing on or off

Equipment working mode selection

9. Initial Operation and Setting

9.1 Attention

- Do adjustment after electrical safety inspection.
- After the power is switched on, start the test running of heat pump, to see if it can function well.
- Forced operation is forbidden, because it is very dangerous to work without protector.

9.2 Preparation Before Adjustment

- Check that the system is installed correctly.
- Pipes and cables are connected correctly.
- Check that accessories are installed.
- Make sure the drainage is working properly.
- Make sure the system piping and connections are properly insulated.
- Check that ground/earth connection had been made correctly.
- Check that supply voltage can meet the requirement of rated voltage.
- Check that air inlet and outlet are working correctly.
- Check that the electrical leakage protector works correctly.

9.3 Adjustment Process

- Check that switch of display controller works properly.
- Check that function keys on display controller work properly.
- Check that indicator lights work properly.
- Check that drainage works properly.
- Check that system works correctly after starting up.
- Check that water outlet temperature is acceptable.
- Check if there are vibrations or abnormal sounds when the system is functioning.
- Check if the wind, noise and condensate water produced by the system affect the surrounding environment.
- Check if there is any refrigerant leakage.
- If any fault occurs, please check the instructions first to analyze and remove the fault.

10. Operation and maintenance

10.1 The heat pump should be installed and operated by qualified professionals. To ensure the continued correct functioning of the system it is recommended that it should be checked and maintenance should be carried out at regular. During maintenance, please pay attention to the points below:

- Check that all parameters are normal during system operation.
- Check for loose electrical connections and fix if necessary.
- Check electrical components and replace if necessary.
- After prolonged use, there may be calcium or other mineral substances deposited on the surface of the heat exchanger copper coil. This could affect the performance of heat exchanger and lead to higher than normal electrical consumption, increased discharge pressure and reduced suction pressure. Formic acid, citric acid, acetic acid or other organic acid can be used to clean the coil.
- Any dirt accumulated on the surface of the evaporator fins should be blown away using a 0.6Mpa air compressor, brushed by fine copper wire, or flushed with a high-pressurized water hose, usually one time per month. If there is too much dirt, we can use a paintbrush dipped in gasoline to clean the evaporator.
- After restarting the unit following a long period of inactivity, please do the following: examine and clean the equipment carefully, clean the water pipe system, check the water pump and fasten all the wire connections.
- Always use original replacement parts.

10.2 Refrigerant

Check the refrigerant filling condition by reading the data of the liquid level from the display screen, and also by checking the air suction and exhaust pressure. If there is a leakage or any components of the refrigeration circulation system have been changed, it is necessary to check the air tightness before anything else.

10.3 Leak detection and air tightness testing

During leak detection and air tightness experiment, never allow oxygen, ethane or other harmful flammable gases to enter the system: only compressed air, fluoride or refrigerant can be used for such a test.

10.4 To remove the compressor, please do the following

- Turn off the power supply
- Remove the refrigerant from the low pressure end; make sure you reduce the exhaust speed, and avoid leakage of frozen oil.

-
- Remove the compressor air suction and exhaust pipe.
 - Remove the compressor power cables.
 - Remove the compressor fixing screws.
 - Remove the compressor.

10.5 Conduct regular maintenance according to the user manual instruction, to make sure the unit running is in good condition.

- If there is a fire, disconnect the power immediately and put the fire out with fire extinguisher.
- The unit's operating environment should be free of gasoline, ethyl alcohol and other flammable materials to avoid explosions or fire.
- Malfunction: if any malfunction occurs, find the reason, fix it and then reboot the unit. Never reboot the unit forcibly if the cause of the malfunction has not been eliminated. If there is refrigerant leakage or frozen liquid leakage, switch the unit off. If it is not possible to turn the unit off from the controller then disconnect the main power supply..
- Never short connect the wire for device protection otherwise, in case unit malfunction, the unit will not be protected normally and could be damaged.

11. Fault analysis and Solution method

Fault	Possible cause	Detection and elimination method
Discharge pressure is too high.	<ul style="list-style-type: none"> ◆ There is air or other non-condensable gas existed in the system. ◆ Water heat exchanger is scaling or fouling blockage. ◆ The circulation water volume is not enough. ◆ Refrigerant charging is too much. 	<ul style="list-style-type: none"> ● Vent the air from water heat exchanger ● Wash and clean the water heat exchanger ● Examine the water system pipeline and pump. ● Drain part of the refrigerant
Discharge pressure is too low.	<ul style="list-style-type: none"> ◆ Liquid refrigerant flow through evaporator to compressor, which make foam for the frozen oil ◆ Suction pressure is too low ◆ Refrigerant charging is too less, the refrigerant air goes into liquid pipeline 	<ul style="list-style-type: none"> ● Examine and adjust the expansion valve, make sure the expansion valve temperature sensor bulb is close connected with the air suction pipe, and absolutely insulated with the ambient environment. ● Please refer to "Fluorine filling if suction pressure too low"
Suction pressure is too high.	<ul style="list-style-type: none"> ◆ Discharge pressure is too high. ◆ Refrigerant charging is too much. ◆ Liquid refrigerant flow through evaporator to compressor. 	<ul style="list-style-type: none"> ● Drain part of the refrigerant. ● Examine and adjust the expansion valve, make sure the expansion valve temperature sensor bulb is close connected with the air suction pipe, and absolutely insulated with the ambient environment.
Suction pressure is too low.	<ul style="list-style-type: none"> ◆ Ambient temperature is too low. ◆ The evaporator liquid inlet or compressor suction pipe is blocked, expansion valve unadjusted, or failed. ◆ The refrigerant is not enough in the system. 	<ul style="list-style-type: none"> ● Adjust suitable overheat temperature, examine whether there is Fluorine leakage from the expansion valve temperature sensor bulb. ● Examine Fluorine leakage. ● Examine the installation condition.
Compressor stopped because of high pressure protection.	<ul style="list-style-type: none"> ◆ The water inlet temperature is too high, circulation water is not enough. ◆ The high pressure stop setting is not correct, the air suction overheat greatly. ◆ Fluorine filling is too much. 	<ul style="list-style-type: none"> ● Examine water system pipeline and water pump. ● Examine the high pressure switch. ● Examine the Fluorine filling volume, drain part of refrigerant.
Compressor stopped because of motor overloading.	<ul style="list-style-type: none"> ◆ The voltage is too high or too low. ◆ Discharge pressure is too high or too low. ◆ Device loading failure. ◆ Ambient temperature is too high. ◆ Motor or connecting terminal is in short circuit. 	<ul style="list-style-type: none"> ● The voltage should be controlled within more or less 20V than rated voltage, and phase difference within $\pm 30\%$. ● Examine the compressor current, compare with the full loading current indicated in the user manual. ● Improve air ventilation.
Compressor stopped because of built-in thermostat.	<ul style="list-style-type: none"> ◆ The voltage is too high or too low. ◆ Discharge pressure is too high. ◆ The refrigerant in the system is not enough. 	<ul style="list-style-type: none"> ● Examine the voltage to make sure it is within the specialized range. ● Examine the discharge pressure and find out the reason. ● Examine whether there is Fluorine leakage.
Compressor stopped because of low voltage production	<ul style="list-style-type: none"> ◆ Dry filter clogging. ◆ Expansion valve failure. ◆ The refrigerant is not enough. 	<ul style="list-style-type: none"> ● Examine, maintain, or change dry filter. ● Adjust or change expansion valve. ● Fill in refrigerant.
High noise of compressor	<ul style="list-style-type: none"> ◆ There is liquid hammer for liquid refrigerant flowing through evaporator to compressor. 	<ul style="list-style-type: none"> ● Adjust liquid supply, examine whether normal for the expansion valve and air suction over heat degree.
Compressor can not start.	<ul style="list-style-type: none"> ◆ Over current relay is tripped, insurance is burn. ◆ The control circuit is not connected. ◆ No current. ◆ The pressure is too low, which can not conduct the pressure switch. ◆ The contactor coil is burn out. ◆ Water system failure, relay is tripped. 	<ul style="list-style-type: none"> ● Set the control circuit in manul mode, restart the compressor after maintenance. ● Examine controlling system. ● Examine power supply. ● Examine whether the refrigerant is too less. ● Reconnect, adjust two of the wiring.

12. Technical parameter

Model No.	BYC-007TG1	BYC-010TG1	BYC-013TG1	BYC-017TG1	BYC-021TG1	BYC-030TG1	BYC-030TG3	
Heating Capacity at Air 26°C, Humidity 80%, Water 26°C in, 28°C out								
Heating Capacity (kW)	7.7~1.8	10~2.3	13.2~3.1	17.1~3.9	21~4.9	28.2~6.9	28.4~7.1	
Power Input (kW)	1.13~0.11	1.45~0.15	1.91~0.19	2.51~0.25	3.09~0.31	4.15~0.44	4.18~0.45	
COP	15.8~6.8	15.8~6.9	16~6.9	15.9~6.8	15.8~6.8	15.8~6.8	15.8~6.8	
Heating Capacity at Air 15°C, Humidity 70%, Water 26°C in, 28°C out								
Heating Capacity (kW)	5.7~1.3	7.9~1.8	10.1~2.3	12.8~2.9	15.9~3.6	22.1~5.0	22.1~5.0	
Power Input (kW)	1.16~0.17	1.58~0.23	2.03~0.30	2.57~0.38	3.20~0.47	4.43~0.65	4.44~0.65	
COP	7.6~4.9	7.6~4.9	7.6~4.9	7.6~4.9	7.6~4.9	7.6~4.9	7.6~4.9	
Cooling Capacity at Air 35°C, Water 29°C in, 27°C out								
Cooling Capacity (kW)	4.2~1.1	5.9~1.5	7.2~1.8	9.4~2.3	11.5~2.9	15.8~3.9	15.9~3.9	
Power Input (kW)	1.13~0.17	1.57~0.22	1.89~0.26	2.51~0.34	3.16~0.43	4.19~0.56	4.18~0.56	
EER	6.6~3.7	6.7~3.7	6.9~3.8	6.9~3.8	6.9~3.7	6.9~3.8	6.9~3.8	
Power supply	220~240V / 1/ 50 Hz						~415V / 3/ 50	
Max Power Input (kW)	1.2	1.6	2.1	2.6	3.2	4.4	4.5	
Max Current(A)	5.5	7.3	9.6	11.9	14.5	20	8.4	
Refrigerant	R32							
Heat Exchanger	Titanium							
Air Flow Direction	Horizontal							
Water Flow Volume (m ³ /h)	2.5	3.5	4.5	5.5	6.5	9	9	
Automatic defrosting	by 4 way valve							
Working temperature range (°C)	-15 ~ 43							
Noise level (dB(A))	≤ 42	≤ 43	≤ 45	≤ 45	≤ 45	≤ 49	≤ 49	
Net Dimensions (mm)(L * W * H)	821*405*587		850*405*637			1036*448*739		
Package Dimensions (mm)(L * W *H)	883*435*722		912*435*777			1098*488*879		
Net Weight(kg)	42	44	53	56	60	88	88	
Gross Weight(kg)	53	55	64	67	71	99	99	
Water Proof Level	IPX4	IPX4	IPX4	IPX4	IPX4	IPX4	IPX4	

13. After-sale service

If your heat pump does not operate normally, please turn off the unit and cut off the power supply at once, then contact our service center or technical department.